

# Inveo

---

Inveo, a distinctive fusion of modern lines and original design.

The range stands out for its use of high quality elements such as wood veneer worktops, and its combination of matt and glossy materials to produce a fresh contemporary look.

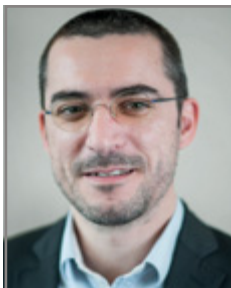

*"Inveo draws inspiration from classic Executive Furniture designs. I am particularly fond of its curved lines and combination of quality traditional and cutting-edge materials."*

**XAVIER DEVAUX** Data and Project Marketing Manager



Making a **statement**



Bringing together  
**curved worktops**  
with delicate  
elliptical leg  
designs







INVEO allows you to create **an entirely personalised workspace**, thanks to its 3 distinctive worktop designs and extensive range of matching complementary storage solutions.



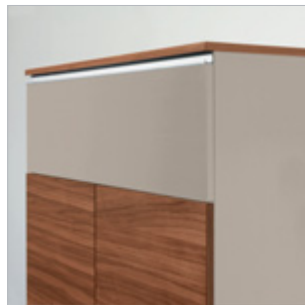
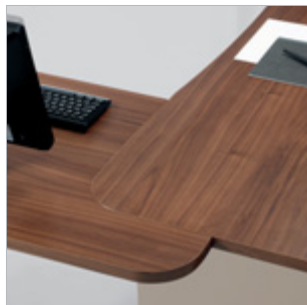









## Shade card

2 choices of finish for wood veneer tops

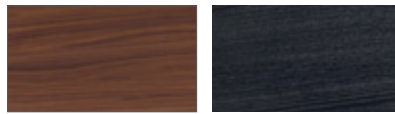

**JN**

Semi-matt  
walnut

**JA**

Black ash

2 choices of finish for methacrylate panel legs (arch-shaped desks)

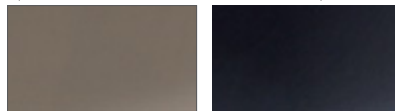

**LF**

Gloss  
cappuccino

**LG**

Gloss black

2 choices of finish for melamine panel legs (curved desks)

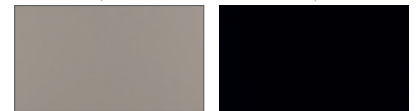

**NY**

Taupe

**NX**

Black

2 choices of finish for elliptical legs



**SA**

Aluminium  
grey

**QN**

Black

Wood veneer panelling is a natural material. It may therefore present variations in colour and pattern particularly when viewed at different angles to the grain and at different angles to the light.

## The Range

Desking and extension units

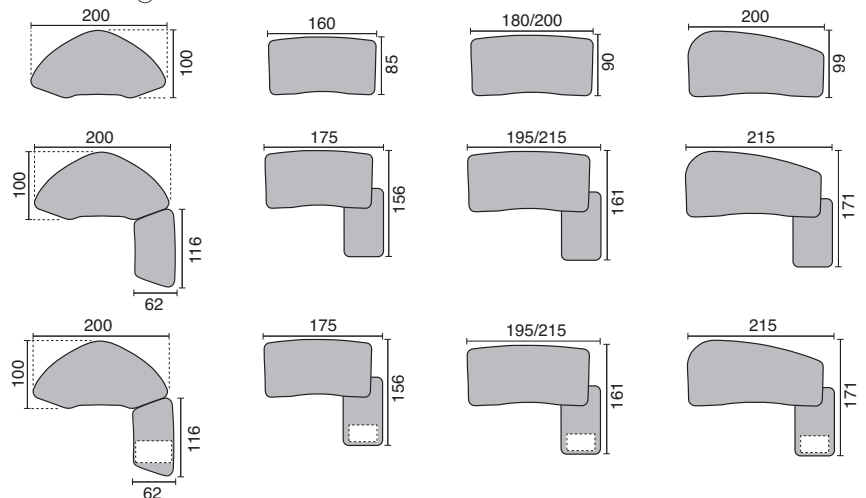

Meeting tables

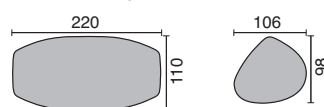

## Standards



## Technical specifications

Desks - height 73.5 cm

**1** Wood veneer worktops, 29 mm thick, with rounded edges. Wood veneer edge banding, 2 mm thick and assorted to the tops. Choice of 3 shapes: arched, pebble shaped and curved.

**2** Elliptical design tubular steel legs 10/10 mm thick. Legs fitted with adjustable stabilizer feet, adjust through 15 mm.

**3** Panel legs particular to the arch-shaped desks. Curved design MDF panel legs with rounded edges, 20 mm thick. High gloss methacrylate finish. Legs fitted with adjustable stabilizer feet, adjust through 15 mm.

**4** Panel legs particular to curved-design desks. Melamine leg panel, cut in arch shape on the visitor side, hardwood veneer panelling. Legs fitted with adjustable stabilizer feet, adjust through 15 mm. 4 possible combinations.

**5** Optional wood veneer modesty panel matching the worktops, height 29 cm and 29 mm thick. Secured to the worktops by means of cam-fittings attached to the curved or pebble shaped desks.

**6** Mobile pedestals or returns match with melamine or glossy methacrylate leg finishes. Tops and drawer fronts in a wood veneer finish matching the worktops. Pedestals with metal drawers fitted on ball-bearing runners, open to depth of 90%. Selective drawer opening. Pen tray. Central locking mechanism.

**7** Meeting tables with elliptical design metal legs. Teardrop shaped worktop, seats 3 to 4 people. Or cylindrical shape worktop, seats 8 to 10 people.

**8** Two types of storage solutions in matching finish:

- Deco storage units composed of cupboards with melamine or glossy methacrylate finish shell. Tops and side panels in wood veneer, with grain direction aligned horizontally. No handles, doors open thanks to 'push & pull' mechanism. Medium and high cupboards fitted with choice of pigeonhole compartment or glossy methacrylate fold-down work surface.

- Traditional storage units composed of melamine cupboards with 19 mm thick shell and shelves. Doors in wood veneer finish matching the worktops. Toughened glass doors 4 mm thick with aluminium frame. Metal handles. 3 point lock on high cupboard. 1 point lock on medium and low cupboards. Glass doors are not lockable. Stabilizer feet H. 28 mm, adjust through 15 mm. Optional tops and side panels in wood veneer finish matching the doors.



## ■ Arch-shaped desks with central panel leg



### Arch-shaped desks

W. 200 x D. 100 cm

3 071 068 + top + leg1 + leg **1670**

### Arch-shaped desks with fixed return on panel leg

Return can be positioned either on left or right side of the desk

W. 200 x D. 200 cm

3 071 127 + top + leg1 + leg **2771**

### Arch-shaped desks with fixed return on elliptical design legs

Return can be positioned either on left or right side of the desk

W. 200 x D. 200 cm

3 071 126 + top + leg1 + leg **2333**

### Arch-shaped desks with fixed return on supporting pedestal

Return can be positioned either on left or right side of the desk. Pedestal shell in methacrylate finish.

W. 200 x D. 200 cm - 2 drawer pedestal

3 071 163 + top + leg1 + leg **3166**

W. 200 x D. 200 cm - 3 drawer pedestal

3 071 164 + top + leg1 + leg **3166**

## ■ Pebble-shaped desk with elliptical design legs



### Pebble-shaped desk

W. 200 x D. 99 cm

3 071 195 + top + leg **1322**

### Pebble-shaped desk with fixed return on elliptical design legs

Return is positioned on right side of the desk

W. 215 x D. 171 cm

3 071 201 + top + leg **2074**

### Pebble-shaped desk with fixed return on supporting pedestal

Return is positioned on right side of the desk.

Pedestal shell in methacrylate LF or LG finish (+col.) or melamine finish NX or NY (+ col.)

Methacrylate shell - 2 drawers

W. 215 x D. 171 cm

3 071 202 + top + col. + leg **2954**

Methacrylate shell - 3 drawers

W. 215 x D. 171 cm

3 071 203 + top + col. + leg **2954**

Melamine shell - 2 drawers

W. 215 x D. 171 cm

3 071 202 + top + col. + leg **2780**

Melamine shell - 3 drawers

W. 215 x D. 171 cm

3 071 203 + top + col. + leg **2780**

## ■ Curved desks on elliptical design legs



### Curved desks

W. 200 x D. 90 cm

3 071 035 + top + leg **1152**

W. 180 x D. 90 cm

3 071 034 + top + leg **1118**

W. 160 x D. 85 cm

3 071 033 + top + leg **1033**

### Curved desks with fixed return on elliptical design legs

#### Left-hand return

W. 215 x D. 161 cm 3 071 050 + top + leg

**1904**

W. 195 x D. 161 cm 3 071 049 + top + leg

**1870**

W. 175 x D. 156 cm 3 071 048 + top + leg

**1785**

#### Right-hand return

3 071 047 + top + leg

**1904**

3 071 046 + top + leg

**1870**

3 071 045 + top + leg

**1785**



**Curved desks with fixed return on supporting pedestal**

Pedestal shell in methacrylate LF or LG finish (+ col.) or melamine finish NX or NY (+ col.)



**Left-hand return**

Methacrylate shell – 2 drawers

W. 215 x D. 161 cm 3 071 080 + top + col. + leg	<b>2754</b>
W. 195 x D. 161 cm 3 071 079 + top + col. + leg	<b>2669</b>
W. 175 x D. 156 cm 3 071 078 + top + col. + leg	<b>2584</b>

**Right-hand return**

3 071 074 + top + col. + leg	<b>2754</b>
3 071 073 + top + col. + leg	<b>2669</b>
3 071 072 + top + col. + leg	<b>2584</b>



Methacrylate shell – 3 drawers

W. 215 x D. 161 cm 3 071 083 + top + col. + leg	<b>2754</b>
W. 195 x D. 161 cm 3 071 082 + top + col. + leg	<b>2669</b>
W. 175 x D. 156 cm 3 071 081 + top + col. + leg	<b>2584</b>

3 071 077 + top + col. + leg	<b>2754</b>
3 071 076 + top + col. + leg	<b>2669</b>
3 071 075 + top + col. + leg	<b>2584</b>

Melamine shell – 2 drawers

W. 215 x D. 161 cm 3 071 080 + top + col. + leg	<b>2610</b>
W. 195 x D. 161 cm 3 071 079 + top + col. + leg	<b>2525</b>
W. 175 x D. 156 cm 3 071 078 + top + col. + leg	<b>2440</b>

3 071 074 + top + col. + leg	<b>2610</b>
3 071 073 + top + col. + leg	<b>2525</b>
3 071 072 + top + col. + leg	<b>2440</b>

Melamine shell – 3 drawers

W. 215 x D. 161 cm 3 071 083 + top + col. + leg	<b>2610</b>
W. 195 x D. 161 cm 3 071 082 + top + col. + leg	<b>2525</b>
W. 175 x D. 156 cm 3 071 081 + top + col. + leg	<b>2440</b>

3 071 077 + top + col. + leg	<b>2610</b>
3 071 076 + top + col. + leg	<b>2525</b>
3 071 075 + top + col. + leg	<b>2440</b>

■ **Curved desks with panel legs**



**Curved desks**

W. 200 x D. 90 cm	3 071 194 + top + leg 2	<b>1271</b>
W. 180 x D. 90 cm	3 071 193 + top + leg 2	<b>1186</b>
W. 160 x D. 85 cm	3 071 192 + top + leg 2	<b>1148</b>



**Curved desks with fixed return on panel leg**

<b>Left-hand return</b>		<b>Right-hand return</b>	
W. 215 x D. 161 cm 3 071 206 + top + leg 2	<b>2240</b>	3 071 209 + top + leg 2	<b>2240</b>
W. 195 x D. 161 cm 3 071 207 + top + leg 2	<b>2155</b>	3 071 210 + top + leg 2	<b>2155</b>
W. 175 x D. 156 cm 3 071 208 + top + leg 2	<b>2117</b>	3 071 211 + top + leg 2	<b>2117</b>



**Curved desks with fixed return on supporting pedestal**  
Pedestal shell in wood veneer finish matching the worktop, pedestal handle in SA or QN finish (+ col.)

<b>Left-hand return</b>		<b>Right-hand return</b>	
2 drawers			
W. 215 x D. 161 cm 3 071 212 + top + leg 2 + col.	<b>2682</b>	3 071 213 + top + leg 2 + col.	<b>2682</b>
W. 195 x D. 161 cm 3 071 214 + top + leg 2 + col.	<b>2597</b>	3 071 216 + top + leg 2 + col.	<b>2597</b>
W. 175 x D. 156 cm 3 071 215 + top + leg 2 + col.	<b>2559</b>	3 071 217 + top + leg 2 + col.	<b>2559</b>
3 drawers			
W. 215 x D. 161 cm 3 071 218 + top + leg 2 + col.	<b>2682</b>	3 071 221 + top + leg 2 + col.	<b>2682</b>
W. 195 x D. 161 cm 3 071 219 + top + leg 2 + col.	<b>2597</b>	3 071 222 + top + leg 2 + col.	<b>2597</b>
W. 175 x D. 156 cm 3 071 220 + top + leg 2 + col.	<b>2559</b>	3 071 223 + top + leg 2 + col.	<b>2559</b>

■ **Optional wood veneer modesty panels**

For curved desks W.200 or 215 cm	3 071 170 + top + leg	<b>306</b>
For curved desks W.180 or 195 cm or pebble shape	3 071 169 + top + leg	<b>285</b>
For curved desks W.160 or 175 cm	3 071 168 + top + leg	<b>255</b>

2 choices of finish for wood veneer tops (+ top)



2 choices of finish for methacrylate panel legs (arch-shaped desks) (+ leg1)



2 choices of finish for melamine panel legs (curved desks) (+ leg2)



2 choices of finish for elliptical design legs (+ leg)



## ■ Meeting tables



### Teardrop shape table - seats 3 to 4 people

Supported by 3 elliptical design legs.

W. 106 x D. 98 cm

3 071 058 + top + leg

**1020**

### Cylindrical shape table - seats 8 to 10 people

Supported by 4 elliptical design legs.

W. 220 x D. 110 cm

3 071 057 + top + leg

**1284**

## ■ Easy reach storage solutions

Wood veneer finish (+top). Methacrylate pedestal shell LF or LG (+ col.) or melamine NX or NY (+ col.). Pedestal handles SA or QN (+ fin.1).



### Mobile pedestals W. 40 x D. 60 x H. 55.20 cm

Methacrylate shell - 2 drawers

3 071 069 + top + col. + fin. 1

**752**

Methacrylate shell - 3drawers

3 071 070 + top + col. + fin. 1

**752**

Melamine shell - 2 drawers

3 071 069 + top + col. + fin. 1

**616**

Melamine shell - 3drawers

3 071 070 + top + col. + fin. 1

**616**

### Mobile returns - 3 drawers W. 118 x D. 64 x H. 56 cm

Methacrylate shell

3 071 071 + top + col. + fin. 1

**1636**

Melamine shell

3 071 071 + top + col. + fin. 1

**1199**

## ■ Deco storage solutions

Cupboard shell in melamine NX or NY - or methacrylate LF or LG (+ fin). Fold-down work surface in melamine NX or NY (+ col.) or methacrylate LF or LG (+ col.)



### Cupboards H. 83.5 x W. 100 x D. 46 cm - 2 wood doors - 1 shelf

2 wood doors

Melamine shell

3 071 153 + top. + fin.

**833**

Methacrylate shell

3 071 153 + top. + fin.

**1505**

### Cupboards H. 115.7 x W. 100 x D. 46 cm - 2 wood doors - 2 shelves

Open top compartment

Melamine shell

3 071 226 + top. + fin.

**927**

Methacrylate shell

3 071 226 + top. + fin.

**1764**

Fold-down work surface

Melamine shell

3 071 155 + top. + fin. + col.

**1058**

Methacrylate shell

3 071 155 + top. + fin. + col.

**1900**

### Cupboards H. 191.7 x W. 100 x D. 46 cm - 4 wood doors - 4 shelves

Open central compartment

Melamine shell

3 071 227 + top. + fin.

**1462**

Methacrylate shell

3 071 227 + top. + fin.

**2520**

Fold-down work surface

Melamine shell

3 071 154 + top. + fin. + col.

**1730**

Methacrylate shell

3 071 154 + top. + fin. + col.

**2784**

### Optional extras for deco storage solutions

Additional melamine shelf

3 071 172 + fin.

**38**

Additional methacrylate shelf

3 071 172 + fin.

**119**

## ■ Traditional storage solutions

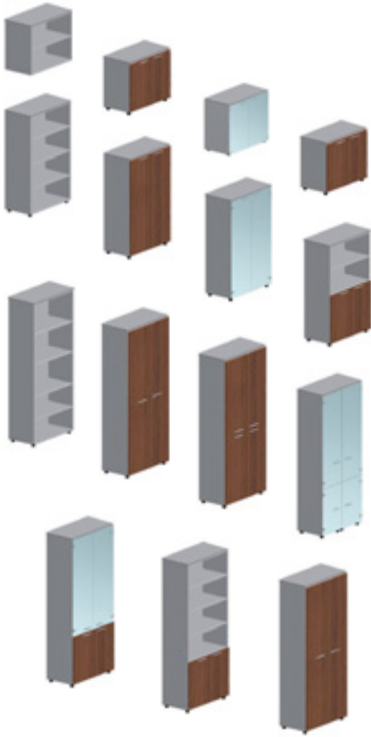

### Low cupboards H. 71 x W. 80 x D. 40.7 (without doors) or D. 42.6 cm – 1 shelf

Without doors	3 071 162 + fin.	<b>128</b>
2 plain doors	3 071 131 + top + fin.	<b>527</b>
2 enamelled glass doors	3 071 133 + glass + fin.	<b>799</b>
Refrigerator unit	3 071 159 + top + fin.	<b>1131</b>

### Medium cupboards H. 133.3 x W. 80 x D. 40.7 (without doors) or D. 42.6 cm – 3 shelves

Without doors	3 071 160 + fin.	<b>221</b>
2 plain doors	3 071 130 + top + fin.	<b>795</b>
2 enamelled glass doors	3 071 132 + glass + fin.	<b>1118</b>
2 plain doors + 1/2 bookcase	3 071 136 + top + fin.	<b>689</b>

### High cupboards H. 197.3 x W. 80 x D. 40.7 (without doors) or D. 42.6 cm – 4 shelves

Without doors	3 071 161 + fin.	<b>255</b>
2 plain doors	3 071 199 + top	<b>1101</b>
4 plain doors	3 071 134 + top	<b>1237</b>
4 enamelled glass doors	3 071 135 + glass + fin.	<b>1832</b>
1/3 plain doors + 2/3 enamelled glass doors	3 071 147 + top + fin. + glass	<b>1517</b>
1/3 plain doors + 2/3 bookcase	3 071 137 + top + fin.	<b>880</b>
Wardrobe	3 071 229 + top + fin.	<b>1245</b>

## ■ Optional extras for traditional storage solutions

### Decorative top 20 mm thick matching the doors D. 43.2 cm

W. 80 cm	3 071 178 + top	<b>187</b>
W. 160 cm	3 071 176 + top	<b>327</b>



### Set of 2 decorative side panels 20 mm thick – Require fitting of decorative top

For cupboard H. 71 cm	3 071 188 + top	<b>293</b>
For cupboard H. 133.3 cm	3 071 186 + top	<b>438</b>
For cupboard H. 197.3 cm	3 071 187 + top	<b>650</b>

### Optional melamine shelf

For cupboard W. 80 cm	3 071 171 + fin.	<b>27</b>
-----------------------	------------------	-----------



### Graphite grey metal shelf for suspension files

For cupboard W. 80 cm	3 071 190 SC	<b>26</b>
-----------------------	--------------	-----------



### Telescopic metal cradle for suspension files

For cupboard W. 80 cm	3 071 228 SG	<b>136</b>
-----------------------	--------------	------------



2 choices of finish for wood veneer tops and doors (+ top)



2 choices of finish for elliptical design legs from stock (+ leg)

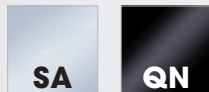

2 choices of finish for glossy enamelled glass doors (+ glass)



2 choices of finish for melamine cupboard shells (+fin)

